

CROWN PROFILES

Crown moulding profiles are typically decorative mouldings designed for use along the intersection of a wall and ceiling. May be combined with other mouldings to create a "built-up" profile.

8" Crown
AZM-43

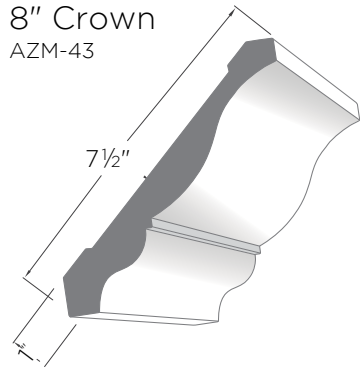

6" Crown
AZM-45

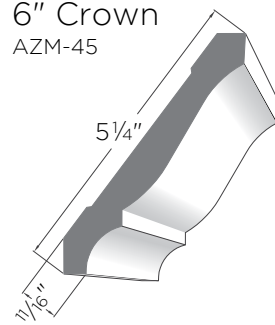

5" Crown
AZM-47

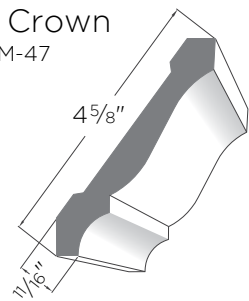

4" Crown
AZM-49

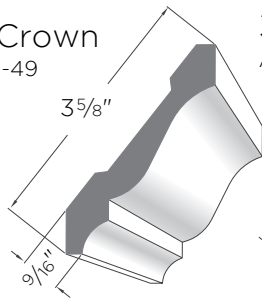

3" Crown
AZM-52

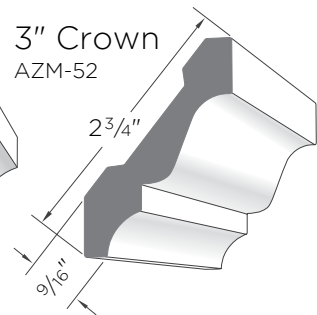

Cove Moulding
AZM-80

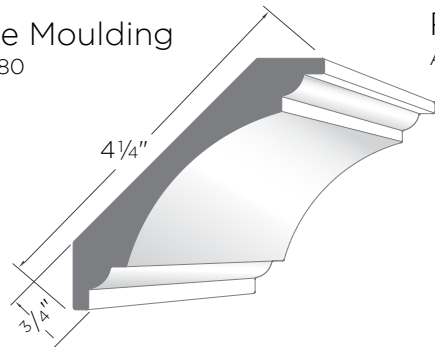

Rams Crown
AZM-6934

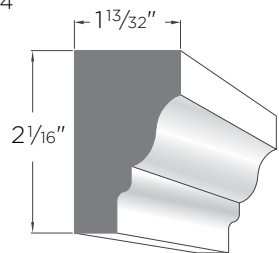

Imperial
Rake
Crown
AZM-6937

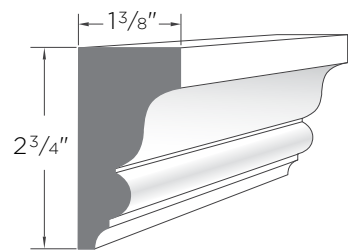

Bed Moulding
AZM-75

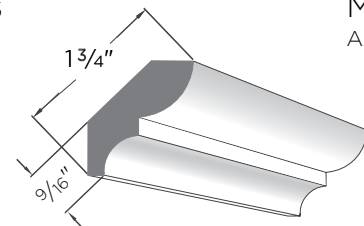

3 1/2" Bed
Moulding
AZM-28

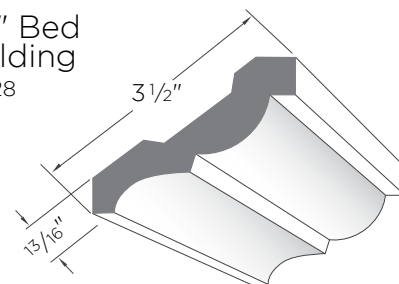

DETAIL & SILL/DRIP PROFILES

Drip Cap is typically used as a water table or brick ledge for separation and water shed against two differing material types. Sill profiles shed water and offer architectural detail.

Drip Cap
AZM-197

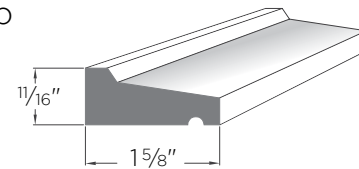

Historic Sill
AZM-6930

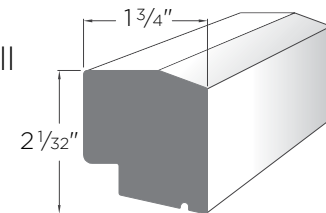

Sub Sill Nose
AZM-6933

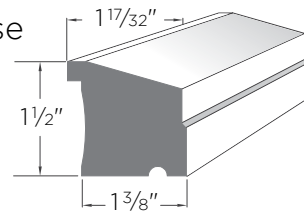

Water Table
AZM-6935

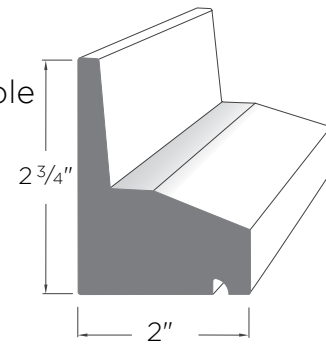

Quarter Round
AZM-105

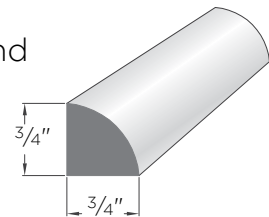

Scotia
AZM-93

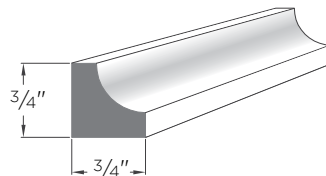

CASING PROFILES

Casing profiles are decorative mouldings typically used flush against a wall, door or window to create surrounds.

Adams Casing
AZM-97

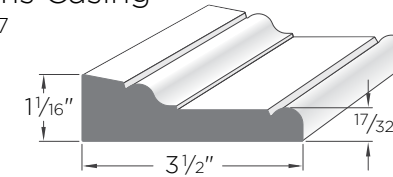

Back Band
AZM-6931

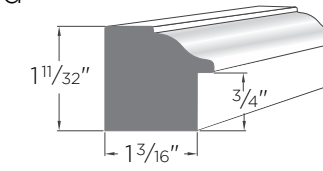

Base Cap
AZM-164

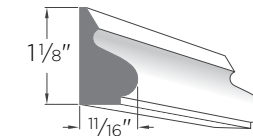

Band Moulding
AZM-217

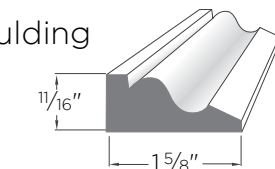

Brick Mould
AZM-180

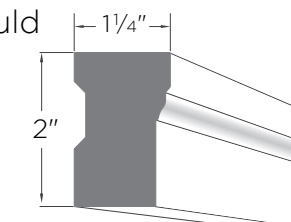

Colonial
Base Cap
AZM-163

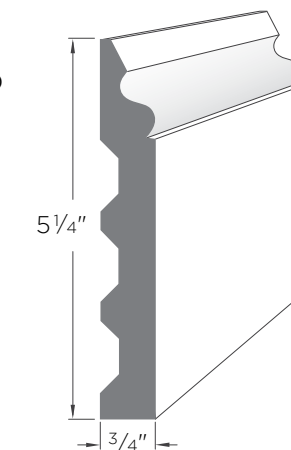

Crosshead Pediment
AZM-6216

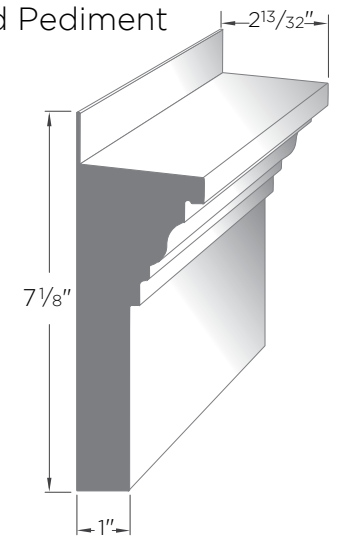

Fluted / Reeded
AZM-606

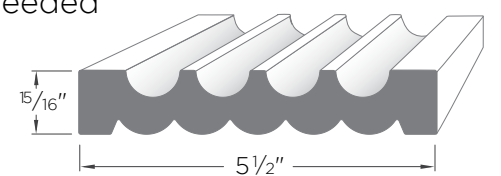

Garage Door Thermostop
AZM-6936

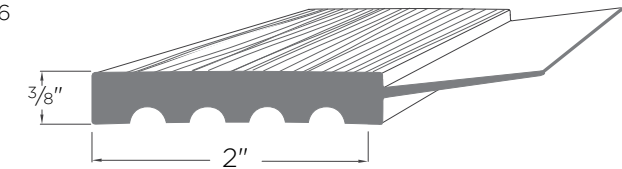

Rake Moulding
AZM-287

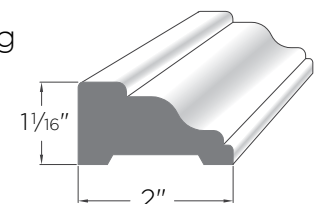

Square Profile
AZM-236

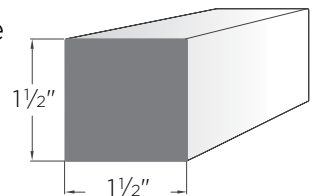

Shingle Mould
AZM-210

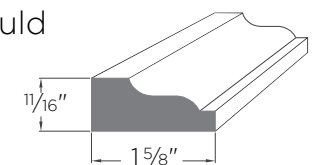

Wainscot Cap
AZM-284

